

OKINA USA

SED4-7610B *Black*

SED4-7610W *White*

Mini Dome Camera - Effio-E

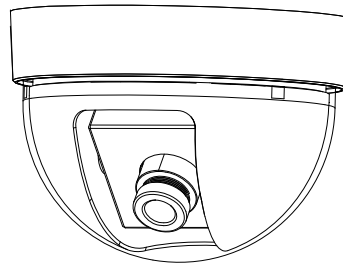



User Manual

Thanks for purchasing our product. Before operating the unit, please read the instructions carefully and keep this manual for future reference.

Safety Warnings

-  **1. Read this manual carefully before installing the unit**

Please read this manual first for correct installation and operation.
-  **2. Never install the camera on a ceiling that cannot hold its weight**

The product may fall down and cause damages.
-  **3. Never install the camera near electric or magnetic fields**

Install the camera away from TV, radio transmitter, magnet, electric motor, transformer, audio speakers since the magnetic fields generate from above devices would distort the video image.
-  **4. Never install or use the camera in areas exposed to water, oil or gas**

The water, oil or gas may result in operation failure, electric shock or fire. Do not use this unit near water-for example, near a bath tub, wash bowl, kitchen sink, or laundry tub, in a wet basement, near a swimming pool, in an unprotected outdoor installation, or any area which is classified as a wet location.
-  **5. Never face the camera toward the sun**

Direct sunlight or severe ray may cause fatal damage to sensor and internal circuit.
-  **6. Power Cord Protection**

Touching the wet power cord with hands or touching the power cord with wet hands may result in electric shock. Power supply cords should be routed so that they are not likely to be walked on or pinched by items placed upon or against them, paying particular attention to cords and plugs, convenience receptacles, and the point where they exit from the appliance.
-  **7. Attachments**

Do not use attachment not recommended by the product manufacturer as they may cause hazards.
-  **8. Object and Liquid Entry**

Never push objects of any kind into this product through openings as they may touch dangerous voltage points or short-out parts that could result in a fire or electric shock. Never spill liquid of any kind onto the product.
-  **9. Do not operate the camera in environments where the temperature, humidity or power source is beyond the specified ones**

Use the camera in suitable environments where the temperature is within -10°C~50°C and humidity below 90%. Use the input power source as the specifications listed.

⚠ 10. Cleaning

Unplug the unit from the outlet before cleaning. Do not use liquid cleaners or aerosol cleaners. Use a damp cloth for cleaning.

⚠ 11. Never disassemble the camera nor put impurities in it

Disassembly or impurities may result in trouble or fire.

⚠ 12. Stop using when the product emits smoke or abnormal heat

⚠ 13. Servicing

Do not attempt to repair this unit yourself as opening or removing covers may expose you to dangerous voltage or other hazards. Refer all servicing to qualified service personnel.

⚠ 14. Retain Instructions

THE SAFETY AND OPERATING INSTRUCTIONS SHOULD BE RETAINED FOR FUTURE REFERENCE.

Warranty

OKINA USA Products are covered under warranty for one year from the date of purchase. The warranty will automatically be voided if any of the following occurs:

1. Camera sticker is removed

If the camera sticker is removed, we will not be able to confirm any information regarding when and where the product was purchased. We have no other way to verify the purchase record without the serial number on the camera sticker; therefore, it should not be removed.

2. Camera is modified in any way

If the camera is scratched, damaged, or modified in a manner not described in this manual, the warranty will be voided immediately. It is the customer's responsibility to keep the camera in good condition.

3. Video or power cable is cut

The video cable and the power cable should not be tampered with. Cutting or modifying of the cables will result in termination of the warranty.

NOTE:

The information in this manual was up-to-date when published. The manufacturer reserves the right to revise and improve its products. All specifications are therefore subject to change without notice.

Table of Contents

1. INTRODUCTION	1
1.1 MAIN FEATURES.....	1
1.2 CONTENT LIST	1
1.3 SPECIFICATIONS.....	2
2. CAMERA OVERVIEW	3
2.1 DIMENSIONS	3
2.2 DESCRIPTION OF CAMERA PARTS	4
3. OSD OPERATION	5
3.1 OSD CONTROL BUTTONS	5
3.2 OSD OPERATION	6
4. CONFIGURATION	7
4.1 LENS	7
4.1.1 AUTO IRIS	7
4.2 SHUTTER/AGC.....	9
4.2.1 AUTO SETUP	9
4.2.2 MANUAL SETUP	10
4.3 NR	11
4.4 WHITE BAL (WHITE BALANCE)	12
4.4.1 ATW (Auto Trace White Balance).....	13
4.4.2 PUSH	13
4.4.3 USER1	13
4.4.4 USER2	14
4.4.5 MANUAL WB (Manual White Balance).....	14
4.4.6 PUSH LOCK	14
4.5 ATR.....	15
4.5.1 ATR ON.....	15
4.6 BACKLIGHT	16
4.7 DAY/NIGHT	17
4.7.1 B/W	17
4.7.2 DAY/NIGHT	18
4.8 PICT ADJUST	19
4.9 MOTION DET (MOTION DETECTION).....	20
4.9.1 MOTION DET ON	20
4.10 PRIVACY	22
4.10.1 PRIVACY ON	22
4.11 CAMERA ID	24
4.11.1 CAMERA ID ON	24
4.12 LANGUAGE.....	26
4.13 CAMERA RESET	27
4.14 SAVE ALL	27
4.15 EXIT.....	27

1. Introduction

SED4-7610B / SED4-7610W built with Sony's latest image processor, this super-wide dynamic camera has the capability of achieving resolutions of over 610TVL. The features include 2D noise reduction, spot removal, strong-light suppression, intelligent motion detection and OSD functions. SED4-7610B / SED4-7610W reproduces nearly perfect images like no other.

1.1 Main Features

- 1/3" Sony 760H Super HAD CCD II
- Sony Effio-E DSP
- Color: 610 TVL, B/W: 630 TVL
- Color: 0.25 Lux @ F2.0, B/W: 0.2 Lux @ F2.0
- Multi-Language OSD Control
- ATR Digital Powerful 128x WDR (52dB)
- Anti-Headlight (HLC)
- 2D Noise Reduction
- High Contrast Images
- Ideal for Backlight Environments
- Mosaic Privacy Mask
- Advanced Motion Detection Function
- Picture Quality Adjustable (Contrast/Sharpness/Hue/Gain)
- 12V DC, 1.5W

1.2 Content List

- One (1) SED4-7610B or SED4-7610W camera with video/power cable
- Two (2) Mounting Screws
- One (1) DC Male Connector
- One (1) Cleaning Cloth
- One (1) Warning Sign Sticker
- One (1) User Manual
- One (1) CD

* For any returns, please include all components listed above with original packaging in **Resalable Condition**. **Absolutely No Returns** will be accepted if any component is missing/damaged or if any cable is cut or tampered with.

1.3 Specifications

PIC	D-229	D-230
Model	SED4-7610B	SED4-7610W
Base Color	Black	White
Image Sensor	1/3" Sony 760H Super HAD CCD II	
Number Of Total Pixels	NTSC: 811(H) x 508(V) / PAL: 795(H) x 596(V)	
Resolution ; DSP	Color: 610 TVL, B/W: 630 TVL ; Sony Effio-E	
Minimum Illumination	Color: 0.25 Lux @ F2.0, B/W: 0.2 Lux @ F2.0	
Wide Dynamic Range	ATR Digital WD (ATR: Adaptive Tone-curve Reproduction) ; 128x Normal Camera (52dB)	
Video Output ; Connector	1.0Vp-p Composite, 75Ω ; BNC	
Signal Noise Ratio	More than 52dB (AGC off, Weight on)	
Gamma Correction	0.45	
Menu	OSD Control	
Title	TITLE (LOCATION)	
Synchronizing System	INTERNAL	
Digital Day&Night Mode	COLOR / B&W / AUTO	
Automatic Electronic Shutter	AUTO (1/50(60)~1/100,000sec.) / MANUAL: 1/50(60), FL 1/120(100), 1/250, 1/500, 1/1,000, 1/2,000, 1/4,000, 1/10,000sec.	
Auto Gain Control	AUTO (4 Steps)	
Auto White Balance	ATW / PUSH / USER1 / USER2 / ANTI CR / MANUAL / PUSH LOCK	
Back Light Compensation	HLC / BLC / OFF	
Flickerless	ON / OFF	
Dynamic Noise Reduction	2D	
Language	ENGLISH / JAPANESE / GERMAN / FRENCH / RUSSIAN / PORTUGUESE / SPANISH / SIMPLIFIED CHINESE	
Motion Detection ; Privacy	ON / OFF (24x16 Zones, Alarm) ; ON / OFF (8 Zones Programmable, Mosaic)	
Lens Mount	Built-in Board Lens	
Lens, Angle of View(H)	3.6mm Standard Lens / F2.0, 72.5°	
Power Input ; Consumption	12V DC ±10% ; 1.5W	
Operation ; Storage Temperature	14°F~122°F ; -4°F~140°F / -10°C~50°C ; -20°C~60°C	
Operation ; Storage Humidity	Maximum:RH80% ; RH90%	
Dimensions	4.41"(DIA) x 2.75"(H) / 112(DIA) x 70(H)mm	
Net Weight	0.44 lbs / 200g	

* Specifications are subject to change without notice

PAL version also available

2. Camera Overview

2.1 Dimensions

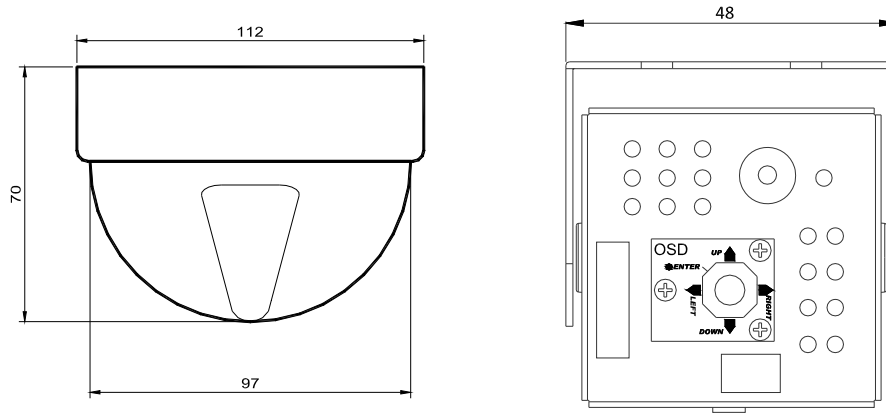

2.2 Description of Camera Parts

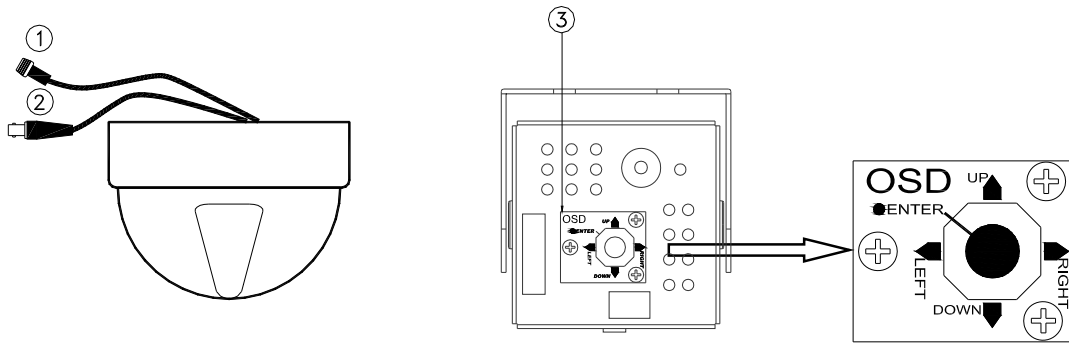

- (1) **Power Input Terminal**
Connect the power input of 12V DC.
- (2) **VIDEO Connector**
This is an output for BNC connection to a video monitor, etc. (75Ω).
- (3) **OSD Control Buttons**
ENTER button
UP & DOWN button
LEFT & RIGHT button

3. OSD Operation

3.1 OSD Control Buttons

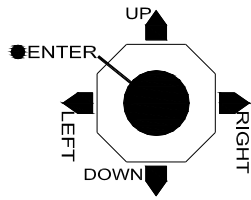

① **U (UP)**

Use this button to move the cursor upwards to the desired item.

② **R (RIGHT)**

Use this button to move the cursor to the right to select or to adjust the parameters of the selected item. The parameter increases when the right button is pressed.

③ **D (DOWN)**

Use this button to move the cursor downwards to the desired item.

④ **L (LEFT)**

Use this button to move the cursor to the left to select or to adjust the parameters of the selected item. The parameter decreases when the left button is pressed.

⑤ **ENTER**

Use this button to display the main menu, to confirm and to enter the submenus when they're available. Items with the symbol "◀" in the end contain sub-menus. For further settings of those items, select the desired item with the button ▲ or ▼ and press the ENTER button to bring up the sub-menu and edit.

3.2 OSD Operation

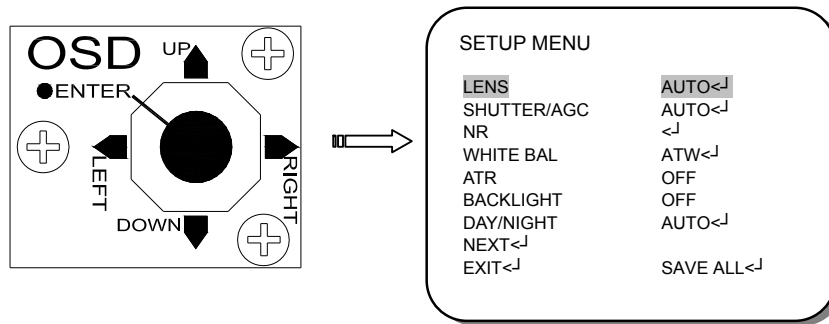

1. Start to operate the OSD menu

Press the **ENTER** button to bring up the OSD main menu to start operating OSD menus.

2. Select items with the cursor buttons

- Use buttons ▲ and ▼ to move the cursor up and down.
- Use buttons ◀ and ▶ to switch the modes or to adjust the parameters or the values of the settings.

3. Switch to the sub-menu

Items with the symbol “<↵” in the end contain sub-menus. For further settings of those items, select the desired item with the button ▲ or ▼ and press the **ENTER** button to bring up the sub-menu and edit.

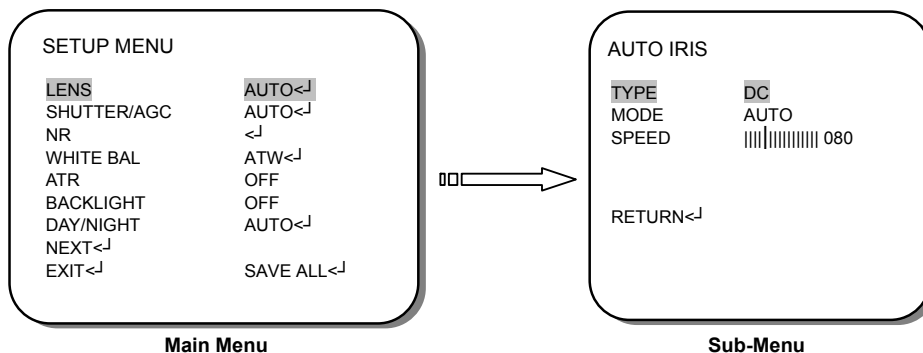

4. Return to the previous page

Select **RETURN** and press the **ENTER** button to return to the previous page.

5. Exit the OSD menu

Select **EXIT** with the button ▲ or ▼ and press the **ENTER** button to exit the OSD menu.

4. Configuration

4.1 LENS

When the **SETUP MENU** is displayed on the screen, use buttons ▲ and ▼ to select the **LENS** and press the **ENTER** button to do further settings.

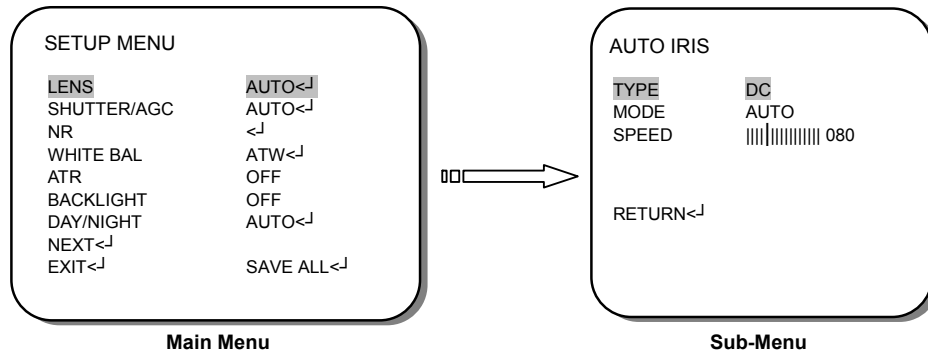

Select to set the mechanical iris of the lens.

Function	Option
LENS	MANUAL AUTO<↓

- **MANUAL**

Auto electronic shutter

- **AUTO<↓**

Auto electronic shutter + Mechanical auto IRIS

When **AUTO<↓** is selected, click **ENTER** to bring up the **AUTO IRIS** sub-menu for further settings.

4.1.1 AUTO IRIS

Adjust the settings of the **AUTO IRIS**.

Function	Option
TYPE	DC VIDEO
MODE	OPEN CLOSE AUTO
SPEED	000 – 255

- **TYPE**

Select to set the type of the mechanical iris.

- **DC**: DC Lens.
- **VIDEO**: VIDEO Lens.

- **MODE**

Select to set the type of control to be exercised over the mechanical iris.

- **OPEN**: The mechanical iris is fixed to open.
- **CLOSE**: The mechanical iris is fixed to close.
- **AUTO**: The mechanical iris is controlled automatically.

- **SPEED**

Select to set the convergence speed of the mechanical iris.

4.2 SHUTTER/AGC

When the **SETUP MENU** is displayed on the screen, use buttons ▲ and ▼ to select the **SHUTTER/AGC** and press the **ENTER** button to do further settings.

SETUP MENU	
LENS	AUTO<↓
SHUTTER/AGC	AUTO<↓
NR	<↓
WHITE BAL	ATW<↓
ATR	OFF
BACKLIGHT	OFF
DAY/NIGHT	AUTO<↓
NEXT<↓	
EXIT<↓	SAVE ALL<↓

Select to set Auto exposure or Manual exposure.

Function	Option
SHUTTER/AGC	AUTO<↓ MANUAL<↓

- **AUTO<↓**:
When **AUTO<↓** is selected, click **ENTER** to bring up the **AUTO SETUP** sub-menu for further settings.
- **MANUAL<↓**:
When **MANUAL<↓** is selected, click **ENTER** to bring up the **MANUAL SETUP** sub-menu for further settings.

4.2.1 AUTO SETUP

Adjust the settings of the **AUTO SETUP**.

Function	Option	Option
HIGH LUMINANCE	MODE	SHUT+AUTO IRIS AUTO IRIS *
	BRIGHTNESS	000 – 255
LOW LUMINANCE	MODE	OFF AGC
	BRIGHTNESS	x0.25 ; x0.50 ; x0.75 ; x1.00

- **HIGH LUMINANCE**
 - **MODE**
Select to specify AE control on the medium- and high-brightness side.
SHUT + AUTO IRIS: Auto electronic shutter + Mechanical auto IRIS
AUTO IRIS: Shutter fix + Mechanical auto IRIS

NOTE:

If **MANUAL** has been selected as the **LENS** function setting, **SHUT** will be displayed, and the settings made in this section will not take effect.

- **BRIGHTNESS**

Select to specify the high- and medium-brightness side reference.

The brightness changes depending on whether the **ATR** function is **ON** or **OFF**, and whether the **CRS** mode has been selected as the **AWB** function.

Please note that the brightness will change when **ATR** or **WHITE BAL** is set to **ANTI CR** (CRS mode), etc., after **BRIGHTNESS** has been set.

• **LOW LUMINANCE**

- **MODE**

Select to specify AE control on the low-brightness side.

OFF: OFF

AGC: Auto gain control

- **BRIGHTNESS**

Select to specify the low-brightness side reference.

4.2.2 MANUAL SETUP

Adjust the settings of the **MANUAL SETUP**.

Function	Option
MODE	SHUT+ AGC
SHUTTER	1/60* ; 1/100* ; 1/250 ; 1/500 ; 1/1000 ; 1/2000 ; 1/4000 ; 1/10000
AGC	6.00 ; 12.00 ; 18.00 ; 24.00 ; 30.00 ; 36.00 ; 42.00 ; 44.80

• **MODE**

"**SHUT+AGC**" is the only option available for the ME operation mode. There are no other options.

• **SHUTTER**

Select to set the ME shutter speed (in fractions of a second).

• **AGC**

Select to set the **AGC** value for ME.

4.3 NR

This item is used to set the noise reduction.

SETUP MENU	
LENS	AUTO<↓
SHUTTER/AGC	AUTO<↓
NR	<↓
WHITE BAL	ATW<↓
ATR	OFF
BACKLIGHT	OFF
DAY/NIGHT	AUTO<↓
NEXT<↓	
EXIT<↓	SAVE ALL<↓

Select to bring up the **NR** sub-menu for further settings.

Function	Option
NR MODE	OFF Y C Y/C
Y LEVEL	000-015
C LEVEL	000-015

- **NR MODE**
Select to set the 2D NR filter mode.
 - **OFF**: Y and C filters OFF
 - **Y**: Y filter ON
 - **C**: C filter ON
 - **Y/C**: Y and C filters ON
- **Y LEVEL**
Select to set the Y filter strength.
- **C LEVEL**
Select to set the C filter strength.

4.4 WHITE BAL (White Balance)

The screen color can be adjusted by using the **WHITE BAL** function.

1. Please use the ▲ and ▼ buttons to **WHITE BAL** on the **SETUP MENU** and press the **ENTER** button to do further settings.
2. Please select the desired item and press ◀ and ▶ buttons to adjust the settings.

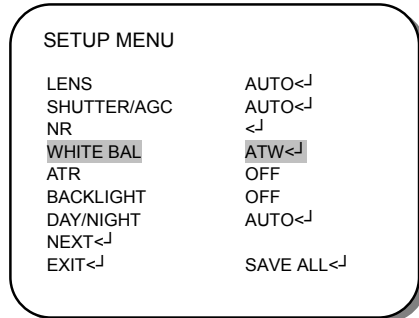

Select to set the white balance Mode.

Function	Option
WHITE BAL	ATW PUSH USER1 USER2 ANTI CR MANUAL PUSH LOCK

- **ATW (Auto Trace White balance)**
When **ATW<↓** is selected, click **ENTER** to bring up the **ATW** sub-menu for further settings.
- **PUSH: All pull-in**
Select to set the white balance mode to the **PUSH** mode.
- **USER1: Fluorescent light fixed gain (3200K)**
When **USER1<↓** is selected, click **ENTER** to bring up the **USER1 WB** sub-menu for further settings.
- **USER2: Outdoor fixed gain (6300K)**
When **USER2<↓** is selected, click **ENTER** to bring up the **USER2 WB** sub-menu for further settings.
- **ANTI CR: Color rolling suppression**
Select to set the white balance mode to the **ANTI CR** mode.
- **MANUAL: Manual white balance**
When **MANUAL<↓** is selected, click **ENTER** to bring up the **MANUAL WB** sub-menu for further settings.

- **PUSH LOCK**

Select to set the white balance mode to the **PUSH LOCK** mode.

4.4.1 ATW (Auto Trace White Balance)

Adjust the settings of the **ATW**.

Function	Option
SPEED	000-255
DELAY CNT	000-255
ATW FRAME	x0.50 ; x1.00 ; x1.50 ; x2.00
ENVIROMENT	INDOOR ; OUTDOOR

- **SPEED**

Select to adjust the pull-in speed of ATW.

- **DELAY CNT**

Select to set the time-based hysteresis of ATW.

- **ATW FRAME**

Select to set the pull-in frame magnification.

- **ENVIROMENT**

Select to set the pull-in frame (indoor/outdoor) of ATW.

4.4.2 PUSH

Select to allow the camera automatically adjust the white balance under all conditions.

4.4.3 USER1

The gain values for the fluorescent light fixed mode are used as the adjustment items of **USER1 WB** on the internal OSD menu.

Function	Option
B-GAIN	000-255
R-GAIN	000-255

- **B-GAIN**

Used for operating the B gain in the WB fixed gain mode.

- **R-GAIN**

Used for operating the R gain in the WB fixed gain mode.

4.4.4 USER2

The gain values for the outdoor fixed mode are used as the adjustment items of **USER2 WB** on the internal OSD menu.

Function	Option
B-GAIN	000-255
R-GAIN	000-255

- **B-GAIN**
Used for operating the B gain in the WB fixed gain mode.
- **R-GAIN**
Used for operating the R gain in the WB fixed gain mode.

4.4.5 MANUAL WB (Manual White Balance)

The B and R gain values for manual WB are set on this screen.

Function	Option
LEVEL	000-255

- **LEVEL**
Select to set the B and R gain values for **MANUAL WB**.
By incrementing or decrementing the B gain value, the R gain value is also adjusted in tandem.

NOTE:

The actual variable range is limited to the range from the low color temperature (approx. 1800K) to the high color temperature (approx. 10500K) stored when the pre-white balance was adjusted.

4.4.6 PUSH LOCK

To find the optimal setting for the current luminance environment in this mode, point the camera towards a sheet of white paper and press the **ENTER** button.

Whenever the condition changes, readjust it.

ATTENTION:

The white balance can not fully function under the following conditions. Please select **PUSH LOCK** Mode when the following occurred.

- < When there's a higher temperature surrounded the object.
- < When there's darkness surrounded the object.
- < When there's a fluorescent light surrounded the object or where the light changes all the time.

4.5 ATR

This item is used to set the Day/Night function.

SETUP MENU	
LENS	AUTO<↵
SHUTTER/AGC	AUTO<↵
NR	<↵
WHITE BAL	ATW<↵
ATR	OFF
BACKLIGHT	OFF
DAY/NIGHT	AUTO<↵
NEXT<↵	
EXIT<↵	SAVE ALL<↵

Select to set **ATR** to **OFF** or **ON**.

Function	Option
LUMINANCE	LOW MID HIGH
CONTRAST	LOW MIDLOW MID MIDHIGH HIGH

- **OFF**
ATR OFF
- **ON**
ATR ON

When **ON**<↵ is selected, click **ENTER** to bring up the **ATR** sub-menu for further settings.

4.5.1 ATR ON

- **LUMINANCE**
Select to set the extent of the luminance compression.
- **CONTRAST**
Select to set the extent of the contrast enhancement.

4.6 BACKLIGHT

This item is used to set the backlight compensation operation.

SETUP MENU	
LENS	AUTO<↓
SHUTTER/AGC	AUTO<↓
NR	<↓
WHITE BAL	ATW<↓
ATR	OFF
BACKLIGHT	OFF
DAY/NIGHT	AUTO<↓
NEXT<↓	
EXIT<↓	SAVE ALL<↓

Select to set **BACKLIGHT** to **OFF**, **BLC** or **HLC**.

Function	Option
BACKLIGHT	OFF BLC HLC

- **OFF**
Backlight compensation OFF.
- **BLC**
Backlight compensation ON.
- **HLC**
HLC(Headlight compensation) function ON.

4.7 DAY/NIGHT

This item is used to set the Day/Night function.

SETUP MENU	
LENS	AUTO<↵
SHUTTER/AGC	AUTO<↵
NR	<↵
WHITE BAL	ATW<↵
ATR	OFF
BACKLIGHT	OFF
DAY/NIGHT	AUTO<↵
NEXT<↵	
EXIT<↵	SAVE ALL<↵

Select to set **DAY/NIGHT** to **AUTO**, **COLOR** or **B/W**.

Function	Option
DAY/NIGHT	AUTO<↵ COLOR B/W

- **AUTO**
Day or Night is automatically identified and controlled accordingly.
When **AUTO<↵** is selected, click **ENTER** to bring up the **DAY/NIGHT** sub-menu for further settings.
- **COLOR**
The Day/Night function is set to **OFF**.
- **B/W**
The NIGHT mode is established forcibly, and chroma is set to **OFF**.
When **B/W<↵** is selected, click **ENTER** to bring up the **B/W** sub-menu for further settings.

4.7.1 B/W

Adjust the settings of **B/W**.

Function	Option
BURST	ON OFF

Select to set whether to output the burst signal when the B/W (NIGHT mode established forcibly) status has been identified.

- **ON**
Burst signal ON
- **OFF**
Burst signal OFF

4.7.2 DAY/NIGHT

Adjust the settings of **DAY/NIGHT**.

Function	Option
BURST	ON OFF
DELAY CNT	000-255
DAY->NIGHT	000-255
NIGHT->DAY	000-255

- **BURST**
Select to set whether to output the burst signal when the Night status has been identified.
 - **ON**: Burst signal ON
 - **OFF**: Burst signal OFF
- **DELAY CNT**
Select to set the Night/Day identification transfer time.
- **DAY->NIGHT**
Select to set the threshold for identifying the Night status from the Day status.
- **NIGHT->DAY**
Select to set the threshold for identifying the Day status from the Night status.

4.8 PICT ADJUST

This item is used to set the PICT ADJUST function.

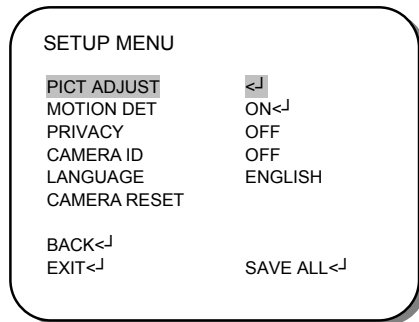

Select to bring up the **PICT ADJUST** sub-menu for further settings.

Function	Option
MIRROR	OFF ON
BRIGHTNESS	000-255
CONTRAST	000-255
SHARPNESS	000-255
HUE	000-255
GAIN	000-255

- **MIRROR**
Select to set the horizontal flip for the display output.
 - **OFF**: Normal output
 - **ON**: Horizontally flipped output
- **BRIGHTNESS**
Select to set the screen brightness.
- **CONTRAST**
Select to set the screen contrast.
- **SHARPNESS**
Select to set the screen sharpness.
- **HUE**
Select to adjust the hue.
- **GAIN**
Select to adjust the color gain.

4.9 MOTION DET (Motion Detection)

This item is used to set the Motion Detection function.

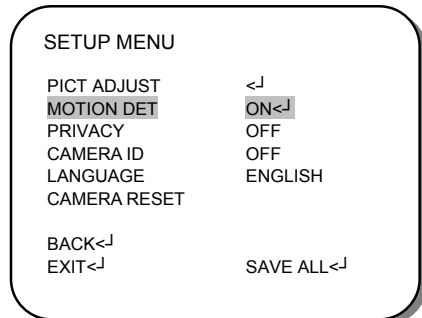

Select to set motion detection to **OFF** or **ON**.

Function	Option
MOTION DET	OFF ON<J

- **OFF**

Motion detection OFF

- **ON**

Motion detection ON

When **ON<J** is selected, click **ENTER** to bring up the **MOTION DET** sub-menu for further settings.

4.9.1 MOTION DET ON

Adjust the settings of **MOTION DET**.

Function	Option
DETECT SENSE	000-127
BLOCK DISP	OFF ON ENABLE
MONITOR AREA	OFF ON
AREA SEL	1/4 ; 2/4 ; 3/4 ; 4/4
TOP	000-244
BOTTOM	000-244
LEFT	000-474
RIGHT	000-474

- **DETECT SENSE**

Select to set the motion detection sensitivity.

- **BLOCK DISP**
Select to control the ON/OFF status of the motion detection block display.
 - **OFF**: No display
 - **ON**: Luminance highlighted

- **MONITOR AREA**
Select to set whether to use the monitoring frames.
 - **OFF**: The monitoring frames are not used.
 - **ON**: The monitoring frames are used.

- **AREA SEL**
Select to define the monitoring frame to be set.

- **TOP/BOTTOM/LEFT/RIGHT**
Select to set the monitoring frame selected with the AREA SEL function.

4.10 PRIVACY

This item is used to set up to eight privacy masks. When monitoring frames are used for motion detection, the maximum number of masks which can be used is four.

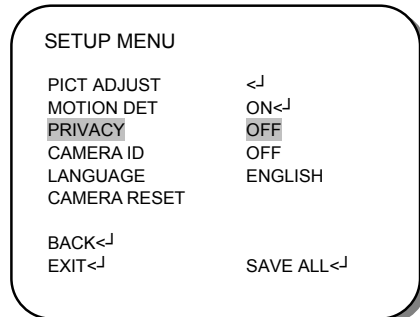

Select to set the masks to **OFF** or **ON**.

Function	Option
PRIVACY	OFF ON<↓

When **ON<↓** is selected, click **ENTER** to bring up the **PRIVACY** sub-menu for further settings.

4.10.1 PRIVACY ON

Adjust the settings of **PRIVACY**.

Function	Option
AREA SEL	1/8 ; 2/8 ; 3/8 ; 4/8 ; 5/8 ; 6/8 ; 7/8 ; 8/8 *
TOP	000-244 (NTSC) ; 000-288 (PAL)
BOTTOM	000-244 (NTSC) ; 000-288 (PAL)
LEFT	000-251(510H)/378(760H)/474(960H)(NTSC) ; 000-246(510H)/370(760H)/468(960H)(PAL)
RIGHT	000-251(510H)/378(760H)/474(960H)(NTSC) ; 000-246(510H)/370(760H)/468(960H) (PAL)
COLOR	1-8
TRANSP	0.00 ; 0.50 ; 0.75 ; 1.00
MOSAIC	OFF ON

- **AREA SEL**

Select to set the mask frame to be adjusted.

NOTE:

When **MONITOR AREA** has been set to **ON** by the **MOTION DET** setting, four frames--1/4, 2/4, 3/4 and 4/4--are selected.

- **TOP/BOTTOM/LEFT/RIGHT**
Select to set the mask frame selected by the AREA SEL parameter.
- **COLOR**
Select to set the colors of the mask frames.
- **TRANSP**
Select to set the transparency ratio of the mask frames.
- **MOSAIC**
Select to set the mask frame mosaic function to ON or OFF.
 - **OFF**: Mosaic function OFF
 - **ON**: Mosaic function ON

4.11 CAMERA ID

This item is used to set the camera ID.

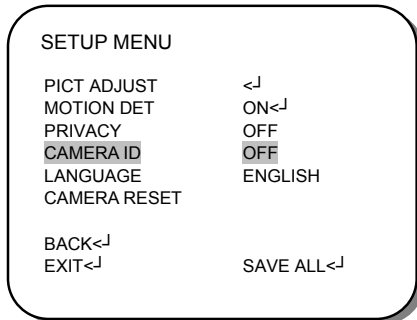

Select to set the camera ID to OFF or ON.

Function	Option
CAMERA ID	OFF ON<J

- **OFF**
Camera ID display OFF
- **ON**
Camera ID display ON
When the **ON<J** is selected, click **ENTER** to bring up the **CAMERA ID** sub-menu for further settings.

4.11.1 CAMERA ID ON

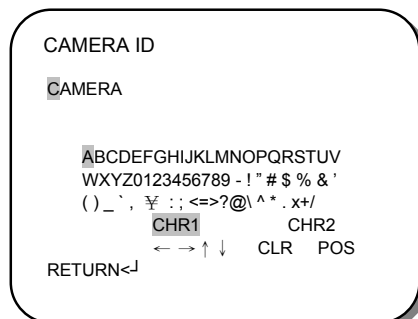

- Select ←, →, ↑ or ↓ with the character selection cursor, and click the **ENTER** button to move the cursor in the direction of the arrow.

- **CLR**
Select to clear one letter of the input.
- **POS**
Adjust the position of the camera ID.

4.12 LANGUAGE

This item is used to select the language in which to display the internal OSD menu.

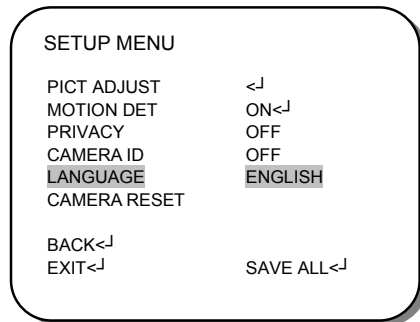

Select to set the language displayed in the OSD menus.

The menus will be changed to the selected language in real time.

Function	Option
LANGUAGE	ENGLISH 日本語 DEUTSCH FRANCAIS РУССКИЙ PORTUGUÊS ESPAÑOL

4.13 CAMERA RESET

Click to restore all the settings to the default values.

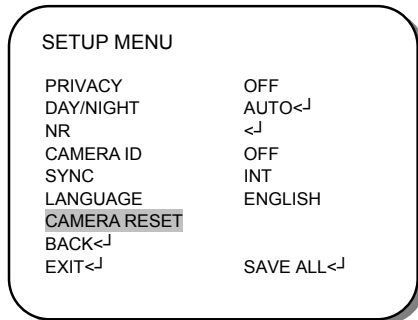

4.14 SAVE ALL

Click to save all the settings made.

NOTE:

There will be no prompt windows while the settings are being saved.

4.15 EXIT

Click to exit the OSD menu.

NOTE:

Before exit the OSD menu, please click **SAVE ALL**<↵ to save all the settings made. Fail to do that, all the settings will not take effect once the power is reconnected.